

SOT-23 Plastic-Encapsulate MOSFETS

2306 N-Channel MOSFET

$V_{(BR)DSS}$	$R_{DS(on)MAX}$	I_D
30V	47mΩ@10V	3.16A
	65mΩ@4.5V	

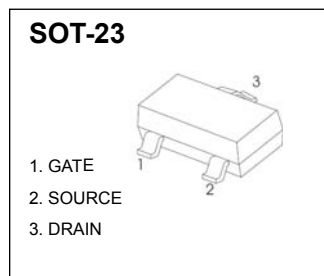

FEATURE

- TrenchFET Power MOSFET

APPLICATION

- Load Switch for Portable Devices
- DC/DC Converter

MARKING

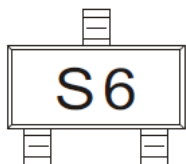

Equivalent Circuit

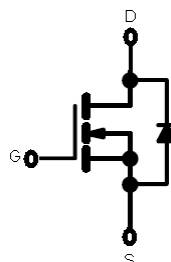

Maximum ratings (at $T_A=25^\circ\text{C}$ unless otherwise noted)

Parameter	Symbol	Value	Unit
Drain-Source voltage	V_{DS}	30	V
Gate-Source Voltage	V_{GS}	± 20	
Continuous Drain Current ($T_J=150^\circ\text{C}$) ^{a,b}	I_D	3.16	A
Pulsed Drain Current	I_{DM}	20	
Continuous Source Current(Diode Conduction) ^{a,b}	I_S	0.62	W
Maximum Power Dissipation ^{a,b}	P_D	0.75	
Thermal Resistance from Junction to Ambient ($t \leq 5s$)	$R_{\theta JA}$	100	$^\circ\text{C/W}$
Operating Junction and Storage Temperature Range	T_J, T_{stg}	-55 to 150	$^\circ\text{C}$

Notes :

- Surface Mounted on 1" × 1" FR4 board, $t \leq 5s$.
- Pulse width limited by maximum junction temperature.

MOSFET ELECTRICAL CHARACTERISTICS

$T_a=25^\circ\text{C}$ unless otherwise specified

Parameter	Symbol	Test Condition	Min	Typ	Max	Unit
Static						
Drain-Source Breakdown Voltage	$V_{(BR)DS}$	$V_{GS} = 0V, I_D = 250\mu A$	30			V
Gate-Threshold Voltage	$V_{GS(th)}$	$V_{DS} = V_{GS}, I_D = 250\mu A$	1.0		3.0	
Gate-Body Leakage	I_{GSS}	$V_{DS} = 0V, V_{GS} = \pm 20V$			± 100	nA
Zero Gate Voltage Drain Current	I_{DSS}	$V_{DS} = 30V, V_{GS} = 0V$			0.5	μA
Drain-Source On-Resistance ^a	$R_{DS(on)}$	$V_{GS} = 10V, I_D = 3.5A$		0.038	0.047	Ω
		$V_{GS} = 4.5V, I_D = 2.8A$		0.052	0.065	
Forward Transconductance ^a	g_{fs}	$V_{DS} = 4.5V, I_D = 2.5A$		7.0		S
Diode Forward Voltage	V_{SD}	$I_S = 1.25A, V_{GS} = 0V$		0.8	1.2	V
Dynamic						
Gate Charge	Q_g	$V_{DS} = 15V, V_{GS} = 5V, I_D = 2.5A$		3.0	4.5	nC
Total Gate Charge	Q_{gt}	$V_{DS} = 15V, V_{GS} = 10V, I_D = 2.5A$		6	9	
Gate-Source Charge	Q_{gs}			1.6		
Gate-Drain Charge	Q_{gd}			0.6		
Gate Resistance	R_g	$f = 1.0\text{MHz}$	2.5	5	7.5	Ω
Input Capacitance	C_{iss}	$V_{DS} = 15V, V_{GS} = 0V, f = 1\text{MHz}$		305		pF
Output Capacitance	C_{oss}			65		
Reverse Transfer Capacitance	C_{rss}			29		
Switching						
Turn-On Delay Time	$t_{d(on)}$	$V_{DD} = 15V,$ $R_L = 15\Omega, I_D \approx 1A,$ $V_{GEN} = 10V, R_g = 6\Omega$		7	11	ns
Rise Time	t_r			12	18	
Turn-Off Delay Time	$t_{d(off)}$			14	25	
Fall Time	t_f			6	10	

Notes :

a.Pulse Test : Pulse Width $\leq 300\mu s$, duty cycle $\leq 2\%$.

Typical Characteristics

Output Characteristics

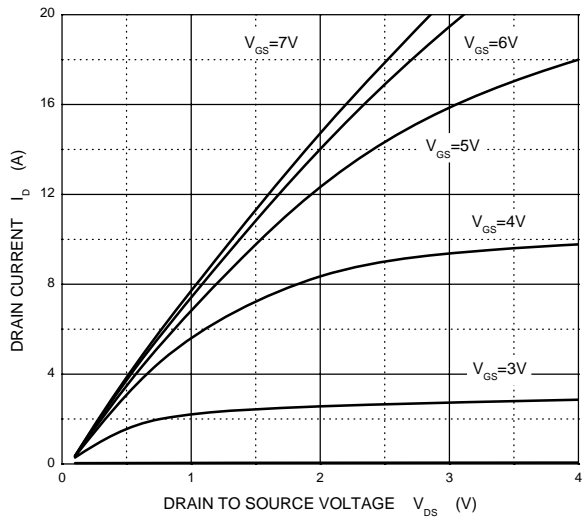

Transfer Characteristics

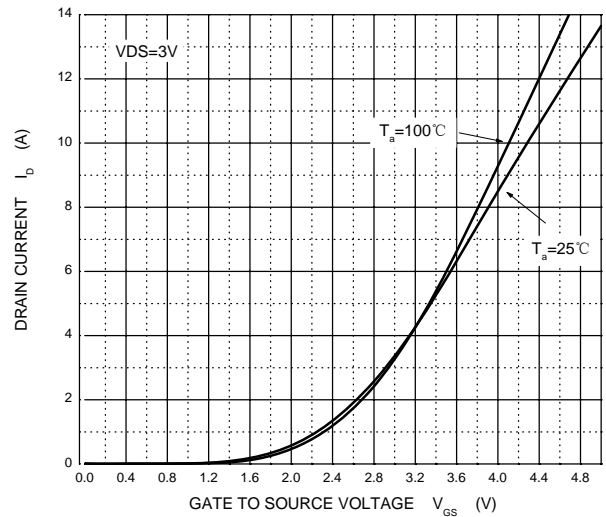

$R_{DS(ON)}$ — I_D

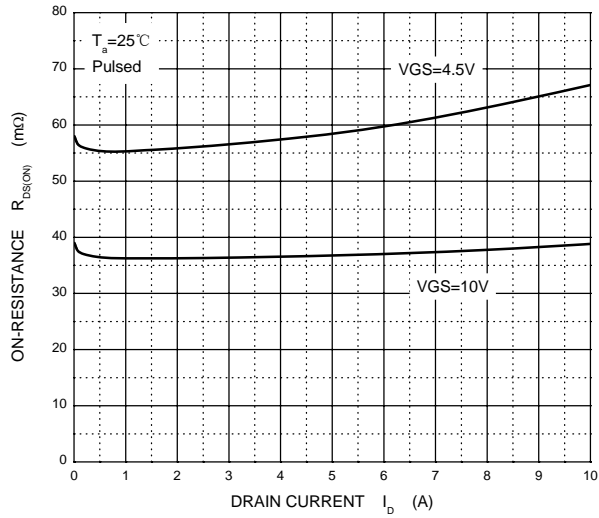

$R_{DS(ON)}$ — V_{GS}

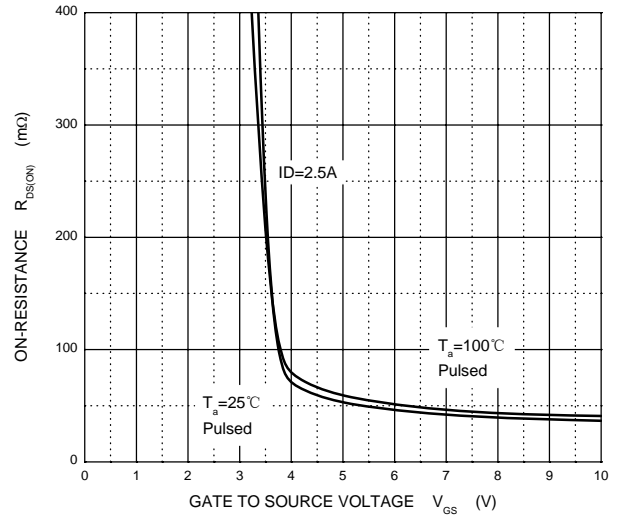

I_S — V_{SD}

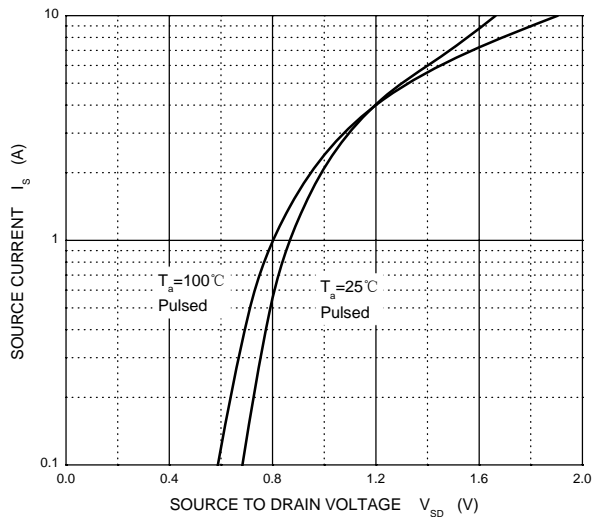

Threshold Voltage

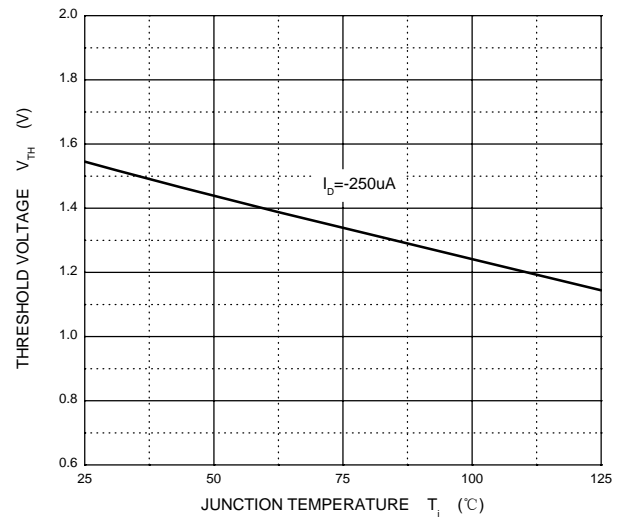

SOT-23 Package Outline Dimensions

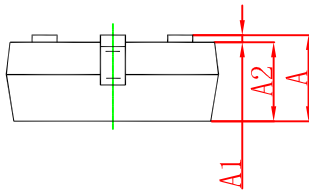
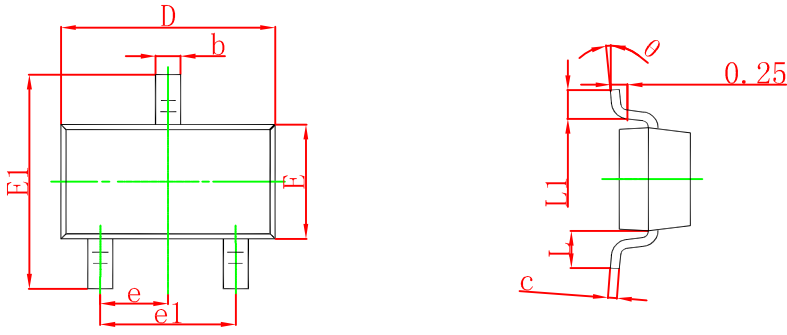

Symbol	Dimensions In Millimeters		Dimensions In Inches	
	Min	Max	Min	Max
A	0.900	1.150	0.035	0.045
A1	0.000	0.100	0.000	0.004
A2	0.900	1.050	0.035	0.041
b	0.300	0.500	0.012	0.020
c	0.080	0.150	0.003	0.006
D	2.800	3.000	0.110	0.118
E	1.200	1.400	0.047	0.055
E1	2.250	2.550	0.089	0.100
e	0.950 TYP		0.037 TYP	
e1	1.800	2.000	0.071	0.079
L	0.550 REF		0.022 REF	
L1	0.300	0.500	0.012	0.020
θ	0°	8°	0°	8°

SOT-23 Suggested Pad Layout

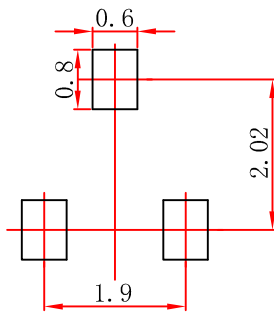

Note:

1. Controlling dimension: in millimeters.
2. General tolerance: ± 0.05 mm.
3. The pad layout is for reference purposes only.

SOT-23 Tape and reel

SOT-23 Embossed Carrier Tape

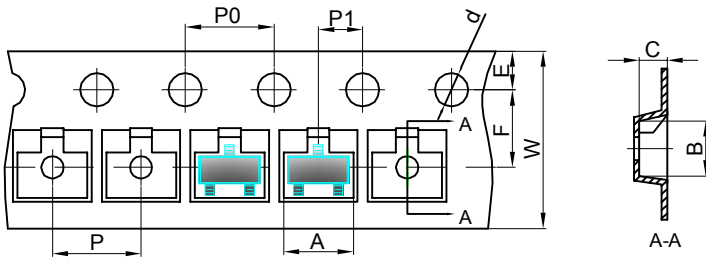

Packaging Description:

SOT-23 parts are shipped in tape. The carrier tape is made from a dissipative (carbon filled) polycarbonate resin. The cover tape is a multilayer film (Heat Activated Adhesive in nature) primarily composed of polyester film, adhesive layer, sealant, and anti-static sprayed agent. These reeled parts in standard option are shipped with 3,000 units per 7" or 17.8cm diameter reel. The reels are clear in color and is made of polystyrene plastic (anti-static coated).

Dimensions are in millimeter										
Pkg type	A	B	C	d	E	F	P0	P	P1	W
SOT-23	3.15	2.77	1.22	Ø1.50	1.75	3.50	4.00	4.00	2.00	8.00

SOT-23 Tape Leader and Trailer

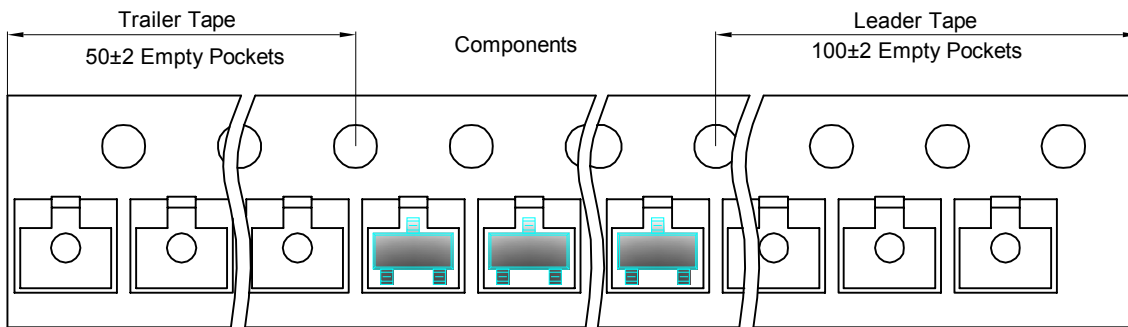

SOT-23 Reel

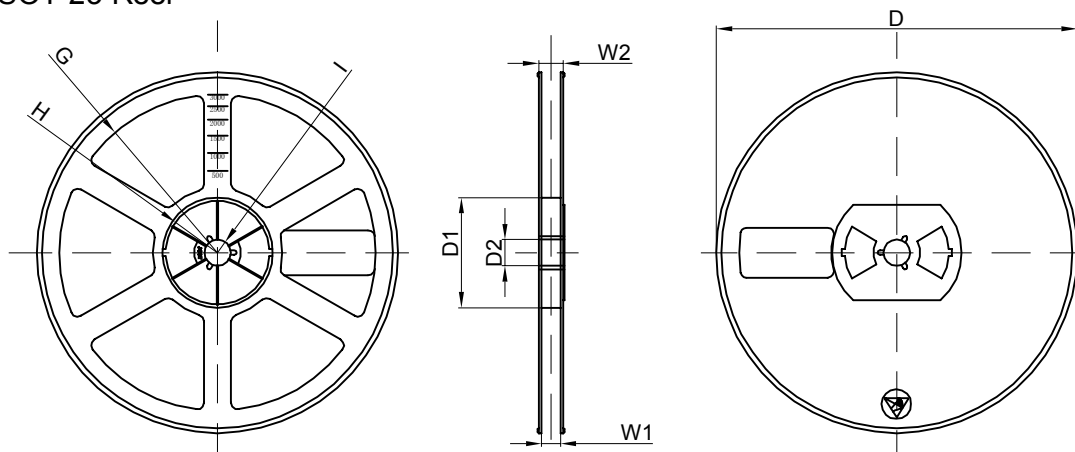

Dimensions are in millimeter								
Reel Option	D	D1	D2	G	H	I	W1	W2
7" Dia	Ø178.00	54.40	13.00	R78.00	R25.60	R6.50	9.50	12.30

REEL	Reel Size	Box	Box Size(mm)	Carton	Carton Size(mm)	G.W.(kg)
3000 pcs	7 inch	30,000 pcs	203×203×195	120,000 pcs	438×438×220	