

# SOT-' 23 Plastic-Encapsulate MOSFETS

## BSS138K      N-Channel 50-V(D-S) MOSFET

| $V_{(BR)DSS}$ | $R_{DS(on)MAX}$ | $I_D$ |
|---------------|-----------------|-------|
| 50V           | 3.5Ω@10V        | 220mA |
|               | 6Ω@4.5V         |       |

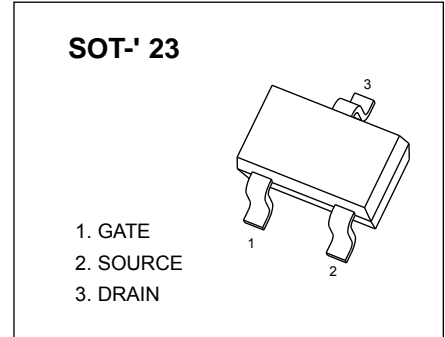

### FEATURE

- High density cell design for extremely low  $R_{DS(on)}$
- Rugged and Reliable

### APPLICATION

- Direct Logic-Level Interface: TTL/CMOS
- Drivers: Relays, Solenoids, Lamps, Hammers; Display, Memories, Transistors, etc.
- Battery Operated Systems
- Solid-State Relays

### MARKING

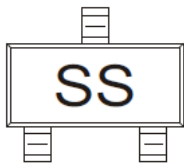

### Equivalent Circuit

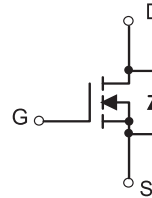

### Maximum ratings ( $T_a=25^\circ\text{C}$ unless otherwise noted)

| Parameter                                   | Symbol          | Value      | Unit                      |
|---|-----------------|------------|---------------------------|
| Drain-Source Voltage                        | $V_{DS}$        | 50         | V                         |
| Continuous Gate-Source Voltage              | $V_{GSS}$       | ±20        |                           |
| Continuous Drain Current                    | $I_D$           | 0.22       | A                         |
| Power Dissipation                           | $P_D$           | 0.3        | W                         |
| Thermal Resistance from Junction to Ambient | $R_{\theta JA}$ | 417        | $^\circ\text{C}/\text{W}$ |
| Operating Temperature                       | $T_j$           | 150        | $^\circ\text{C}$          |
| Storage Temperature                         | $T_{stg}$       | -55 ~ +150 |                           |

## MOSFET ELECTRICAL CHARACTERISTICS

$T_a=25\text{ }^\circ\text{C}$  unless otherwise specified

| Parameter                                      | Symbol        | Test Condition  | Min  | Typ | Max       | Units    |
|--|---------------|---|------|-----|-----------|----------|
| <b>Off characteristics</b>                     |               |   |      |     |           |          |
| Drain-source breakdown voltage                 | $V_{(BR)DSS}$ | $V_{GS} = 0V, I_D = 250\mu A$                                     | 50   |     |           | V        |
| Gate-body leakage                              | $I_{GSS}$     | $V_{DS} = 0V, V_{GS} = \pm 20V$                                   |      |     | $\pm 100$ | nA       |
| Zero gate voltage drain current                | $I_{DSS}$     | $V_{DS} = 50V, V_{GS} = 0V$                                       |      |     | 0.5       | $\mu A$  |
|  |               | $V_{DS} = 30V, V_{GS} = 0V$                                       |      |     | 100       | nA       |
| <b>On characteristics</b>                      |               |   |      |     |           |          |
| Gate-threshold voltage (note 1)                | $V_{GS(th)}$  | $V_{DS} = V_{GS}, I_D = 1mA$                                      | 0.80 |     | 1.50      | V        |
| Static drain-source on-resistance (note 1)     | $R_{DS(on)}$  | $V_{GS} = 10V, I_D = 0.22A$                                       |      |     | 3.50      | $\Omega$ |
|  |               | $V_{GS} = 4.5V, I_D = 0.22A$                                      |      |     | 6         |          |
| Forward transconductance (note 1)              | $g_{FS}$      | $V_{DS} = 10V, I_D = 0.22A$                                       | 0.12 |     |           | S        |
| <b>Dynamic characteristics (note 2)</b>        |               |   |      |     |           |          |
| Input capacitance                              | $C_{ISS}$     | $V_{DS} = 25V, V_{GS} = 0V, f = 1MHz$                             |      | 27  |           | pF       |
| Output capacitance                             | $C_{OSS}$     |   |      | 13  |           |          |
| Reverse transfer capacitance                   | $C_{RSS}$     |   |      | 6   |           |          |
| <b>Switching characteristics</b>               |               |   |      |     |           |          |
| Turn-on delay time (note 1,2)                  | $t_{d(on)}$   | $V_{DD} = 30V, V_{DS} = 10V,$<br>$I_D = 0.29A, R_{GEN} = 6\Omega$ |      |     | 5         | ns       |
| Rise time (note 1,2)                           | $t_r$         |   |      |     | 18        |          |
| Turn-off delay time (note 1,2)                 | $t_{d(off)}$  |   |      |     | 36        |          |
| Fall time (note 1,2)                           | $t_f$         |   |      |     | 14        |          |
| <b>Drain-source body diode characteristics</b> |               |   |      |     |           |          |
| Body diode forward voltage (note 1)            | $V_{SD}$      | $I_S = 0.44A, V_{GS} = 0V$  |      |     | 1.4       | V        |

**Notes:**

1. Pulse Test ; Pulse Width  $\leq 300\mu s$ , Duty Cycle  $\leq 2\%$ .
2. These parameters have no way to verify.

# Typical Characteristics

### Output Characteristics

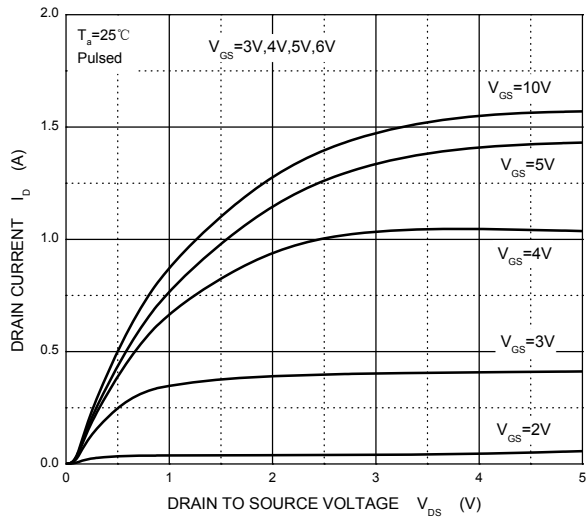

### Transfer Characteristics

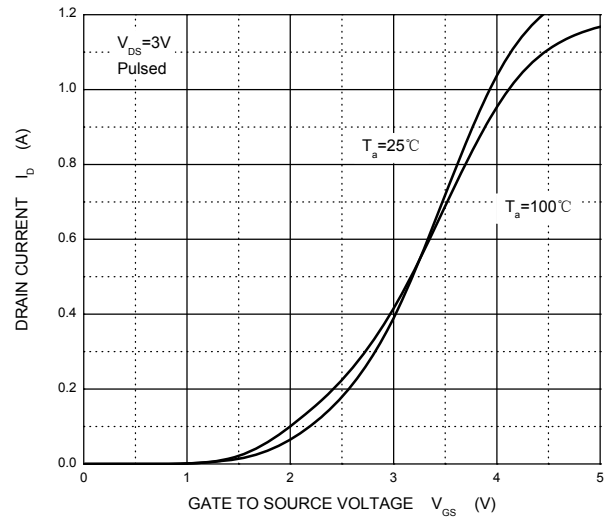

### $R_{DS(ON)}$ — $I_D$

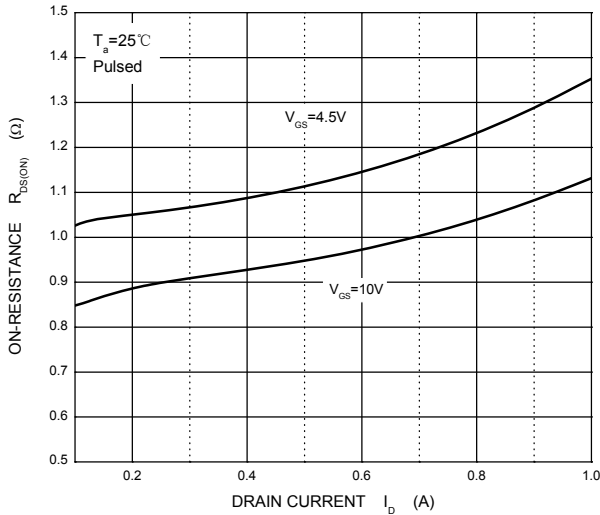

### $R_{DS(ON)}$ — $V_{GS}$

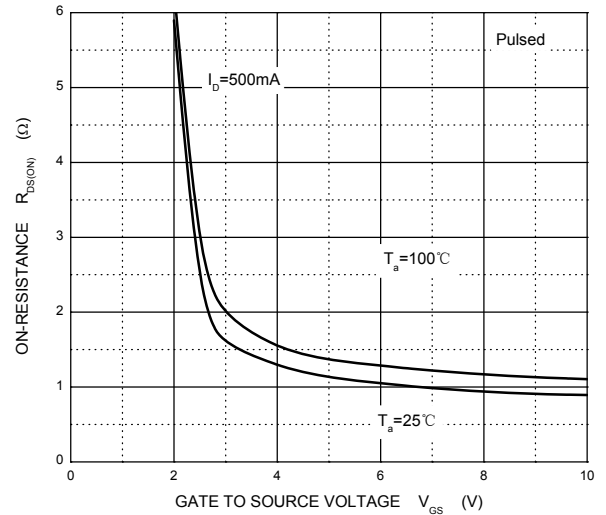

### $I_S$ — $V_{SD}$

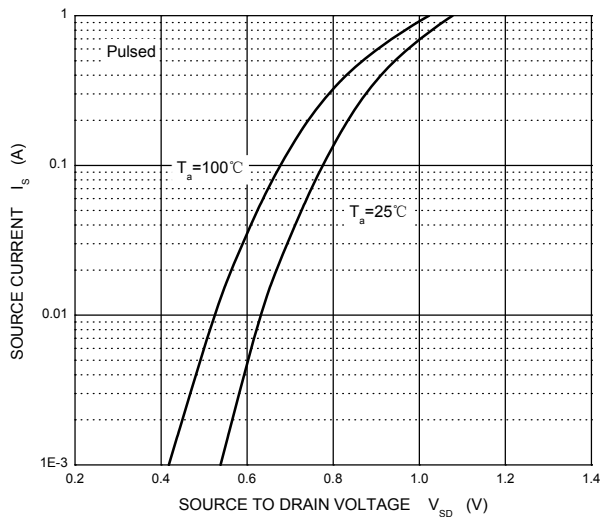

### Threshold Voltage

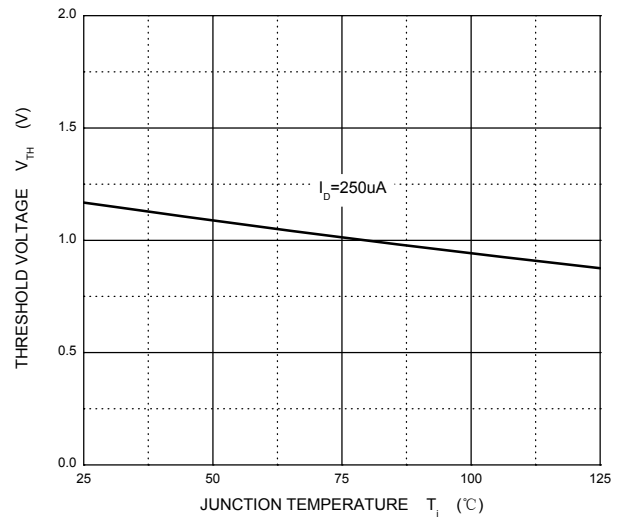

## SOT-323 Package Outline Dimensions

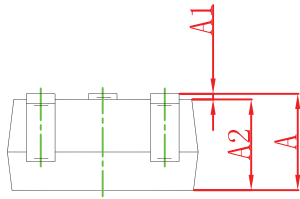
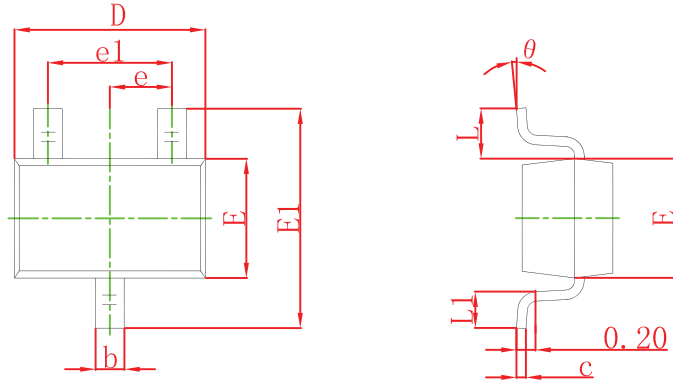

| Symbol   | Dimensions In Millimeters |       | Dimensions In Inches |       |
|----------|---------------------------|-------|----------------------|-------|
|          | Min                       | Max   | Min                  | Max   |
| A        | 0.900                     | 1.100 | 0.035                | 0.043 |
| A1       | 0.000                     | 0.100 | 0.000                | 0.004 |
| A2       | 0.900                     | 1.000 | 0.035                | 0.039 |
| b        | 0.200                     | 0.400 | 0.008                | 0.016 |
| c        | 0.080                     | 0.150 | 0.003                | 0.006 |
| D        | 2.000                     | 2.200 | 0.079                | 0.087 |
| E        | 1.150                     | 1.350 | 0.045                | 0.053 |
| E1       | 2.150                     | 2.450 | 0.085                | 0.096 |
| e        | 0.650 TYP                 |       | 0.026 TYP            |       |
| e1       | 1.200                     | 1.400 | 0.047                | 0.055 |
| L        | 0.525 REF                 |       | 0.021 REF            |       |
| L1       | 0.260                     | 0.460 | 0.010                | 0.018 |
| $\theta$ | 0°                        | 8°    | 0°                   | 8°    |

## SOT-323 Suggested Pad Layout

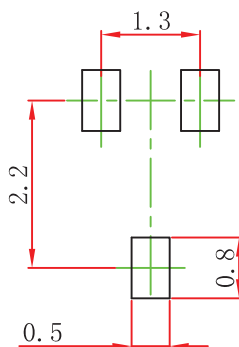

Note:

1. Controlling dimension: in millimeters.
2. General tolerance:  $\pm 0.05$  mm.
3. The pad layout is for reference purposes only.

### NOTICE

SE reserve the right to make modifications, enhancements, improvements, corrections or other changes without further notice to any product herein. SE does not assume any liability arising out of the application or use of any product described herein.

# SOT-323 Tape and Reel

## SOT-323 Embossed Carrier Tape

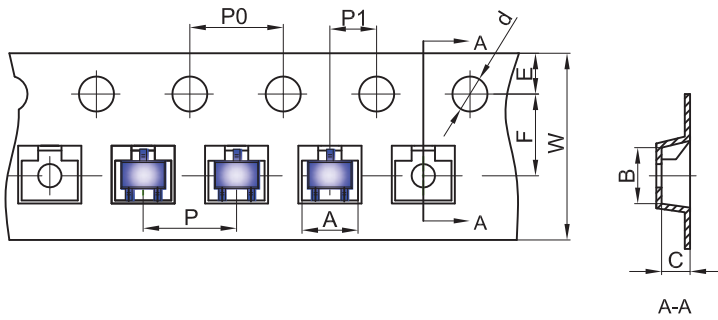

### Packaging Description:

SOT-323 parts are shipped in tape. The carrier tape is made from a dissipative (carbon filled) polycarbonate resin. The cover tape is a multilayer film (Heat Activated Adhesive in nature) primarily composed of polyester film, adhesive layer, sealant, and anti-static sprayed agent. These reeled parts in standard option are shipped with 3,000 units per 7" or 17.8cm diameter reel. The reels are clear in color and is made of polystyrene plastic (anti-static coated).

| Dimensions are in millimeter |      |      |      |       |      |      |      |      |      |      |
|------------------------------|------|------|------|-------|------|------|------|------|------|------|
| Pkg type                     | A    | B    | C    | d     | E    | F    | P0   | P    | P1   | W    |
| SOT-323                      | 2.25 | 2.55 | 1.19 | Ø1.55 | 1.75 | 3.50 | 4.00 | 4.00 | 2.00 | 8.00 |

## SOT-323 Tape Leader and Trailer

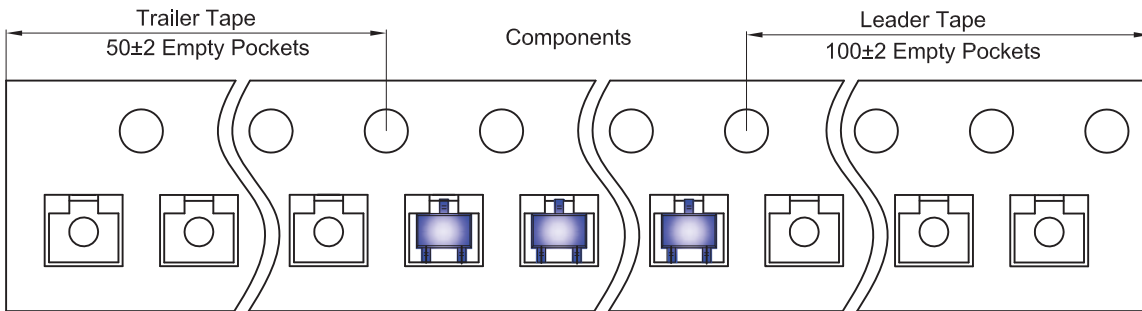

## SOT-323 Reel

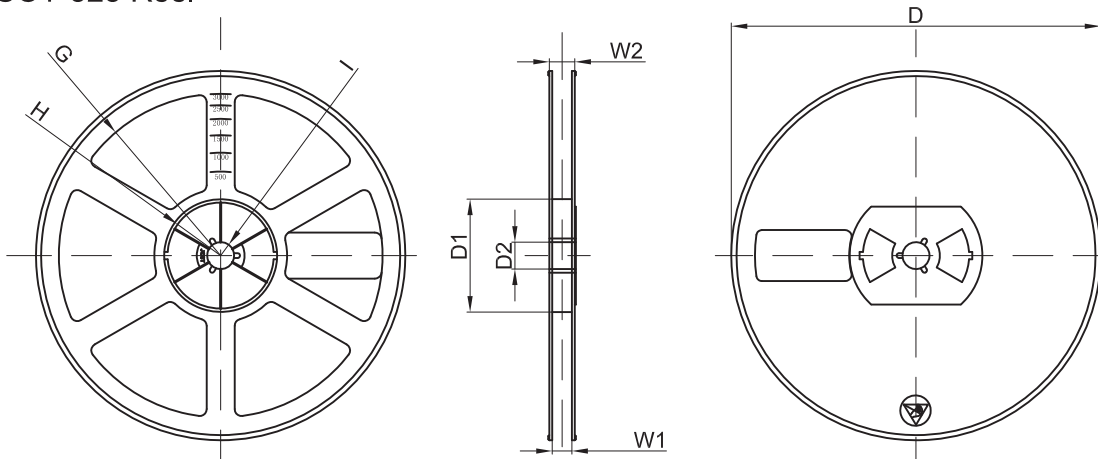

| Dimensions are in millimeter |         |       |       |        |        |       |      |       |
|------------------------------|---------|-------|-------|--------|--------|-------|------|-------|
| Reel Option                  | D       | D1    | D2    | G      | H      | I     | W1   | W2    |
| 7" Dia                       | Ø178.00 | 54.40 | 13.00 | R78.00 | R25.60 | R6.50 | 9.50 | 12.30 |

| REEL     | Reel Size | Box        | Box Size(mm) | Carton      | Carton Size(mm) | G.W.(kg) |
|----------|-----------|------------|--------------|-------------|-----------------|----------|
| 3000 pcs | 7 inch    | 45,000 pcs | 203×203×195  | 180,000 pcs | 438×438×220     |          |