

TVS Diode Array

**Features**

- Ultra low leakage: nA level
- Operating voltage: 12V
- Low clamping voltage
- Complies with following standards:
  - IEC 61000-4-2 (ESD) immunity test
    - Air discharge:  $\pm 15\text{kV}$
    - Contact discharge:  $\pm 8\text{kV}$
  - IEC61000-4-4 (EFT) 40A (5/50ns)
  - IEC61000-4-5 (Lightning) 12A (8/20 $\mu\text{s}$ )
- RoHS Compliant

**Dimensions SOT-23**

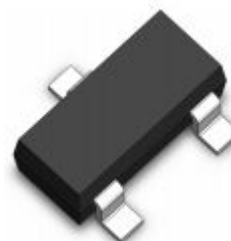

**Pin Configuration**

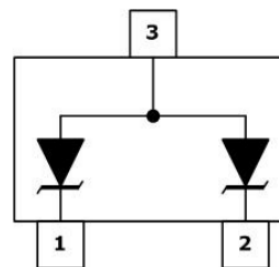

**Applications**

- USB 2.0 power and data line
- Set-top box and digital TV
- Digital video interface (DVI)
- Notebook Computers
- SIM Ports
- 10/100 Ethernet

**Mechanical Characteristics**

- Package: SOT-23
- Lead Finish: Lead Free
- UL Flammability Classification Rating 94V-0
- Quantity Per Reel:3,000pcs
- Reel Size:7inch

**Absolute Maximum Ratings**( $T_{amb}=25^{\circ}\text{C}$  unless otherwise specified)

Parameter	Symbol	Value	Unit
Peak Pulse Power (8/20 $\mu\text{s}$ )	Ppp	300	W
ESD per IEC 61000-4-2 (Air)	V <sub>ESD</sub>	$\pm 15$	Kv
ESD per IEC 61000-4-2 (Contact)		$\pm 8$	
Operating Temperature Range	T <sub>J</sub>	-55 to +125	$^{\circ}\text{C}$
Storage Temperature Range	T <sub>STJ</sub>	-55 to +150	$^{\circ}\text{C}$

**Electrical Characteristics**(TA=25°C unless otherwise specified)

Part Number	Device Marking	V <sub>RWM</sub> (V)	V <sub>BR</sub> (V)	I <sub>T</sub> (mA)	V <sub>C</sub> @1A	V <sub>C</sub>		I <sub>R</sub> μA (Max)	C (Pf) (Typ.)
						(Max)	(@A)		
SM12	M12	12	13.3	1	19	25.9	5	1	150

**Characteristic Curves**

**Fig1. 8/20μs Pulse Waveform**

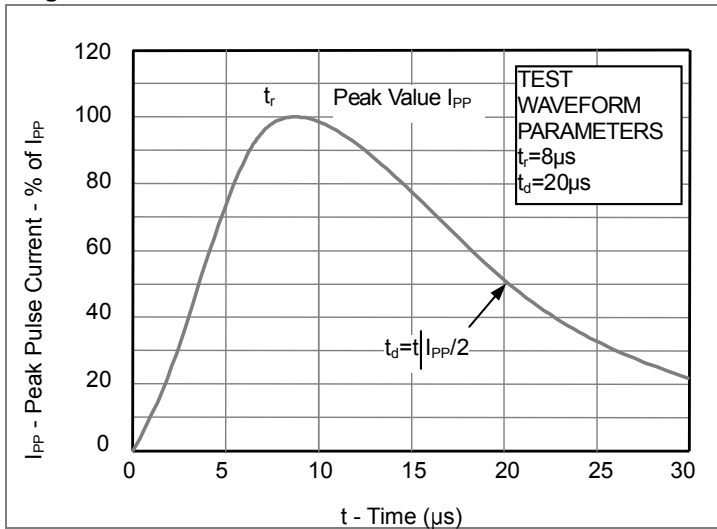

**Fig2. ESD Pulse Waveform (according to IEC 61000-4-2)**

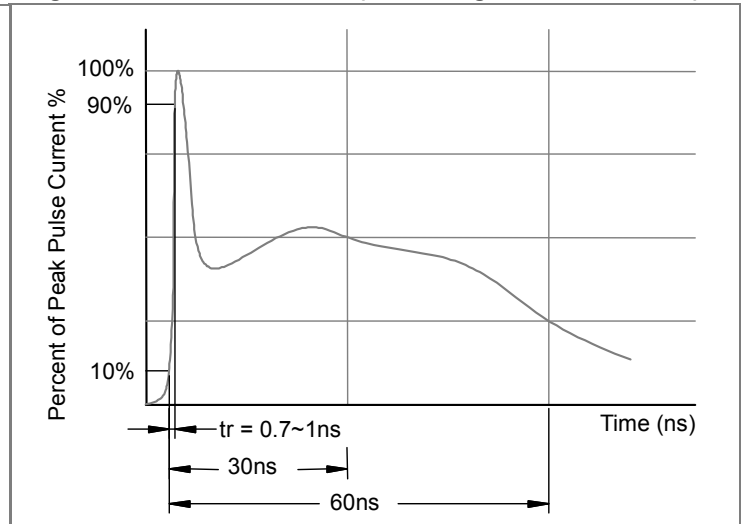

**Fig3. Power Derating Curve**

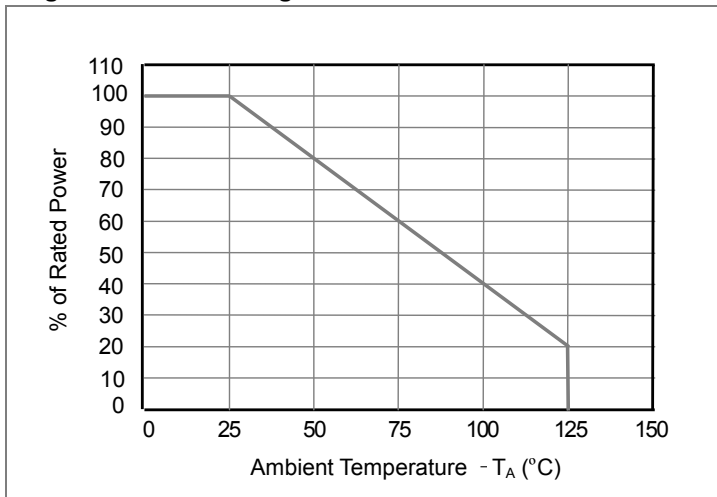

SOT-23 Package Outline & Dimensions

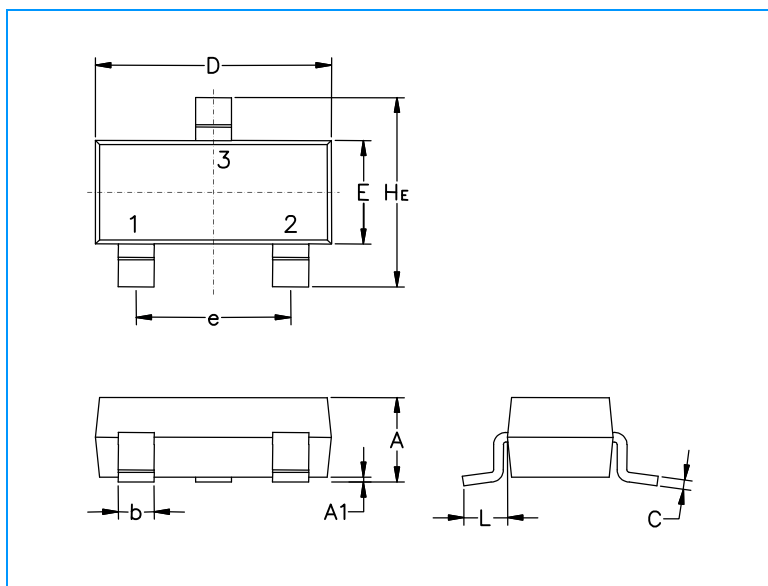

Symbol	Millimeters			Inches		
	Min.	Nom.	Max.	Min.	Nom.	Max.
A	0.89	1.00	1.11	0.035	0.040	0.044
A1	0.01	0.06	0.10	0.001	0.002	0.004
b	0.37	0.44	0.50	0.15	0.18	0.020
c	0.09	0.13	0.18	0.003	0.005	0.007
D	2.80	2.90	3.04	0.110	0.114	0.120
E	1.20	1.30	1.40	0.047	0.051	0.055
e	1.78	1.90	2.04	0.070	0.075	0.081
L	0.35	0.54	0.69	0.014	0.021	0.029
HE	2.10	2.40	2.64	0.083	0.094	0.104

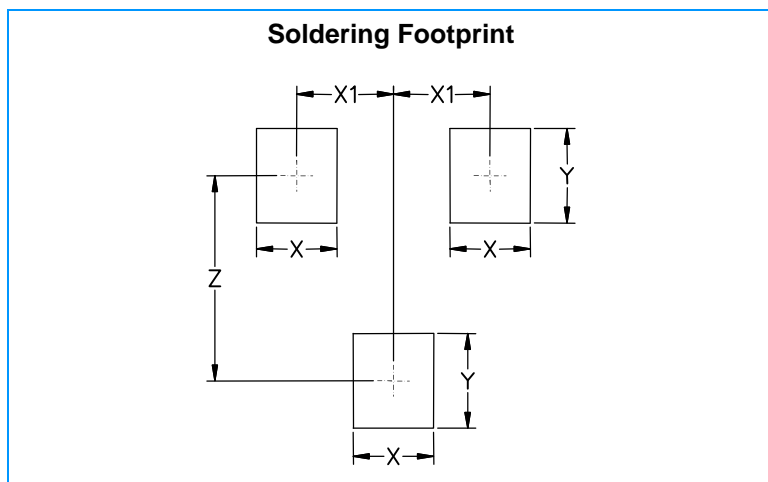

Symbol	Millimeters	Inches
X	0.80	0.031
X1	0.95	0.037
Y	0.90	0.035
Z	2.00	0.079