

1N4933 – 1N4937

1.0A FAST RECOVERY DIODE

Features

- Diffused Junction
- Low Forward Voltage Drop
- High Current Capability
- High Reliability
- High Surge Current Capability

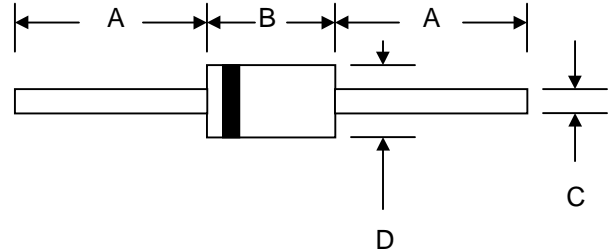

Mechanical Data

- Case: DO-41, Molded Plastic
- Terminals: Plated Leads Solderable per MIL-STD-202, Method 208
- Polarity: Cathode Band
- Weight: 0.34 grams (approx.)
- Mounting Position: Any
- Marking: Type Number
- **Lead Free: For RoHS / Lead Free Version, Add "-LF" Suffix to Part Number, See Page 4**

DO-41		
Dim	Min	Max
A	25.4	—
B	4.06	5.21
C	0.71	0.864
D	2.00	2.72
All Dimensions in mm		

Maximum Ratings and Electrical Characteristics @ $T_A=25^\circ\text{C}$ unless otherwise specified

Single Phase, half wave, 60Hz, resistive or inductive load.
For capacitive load, derate current by 20%.

Characteristic	Symbol	1N4933	1N4934	1N4935	1N4936	1N4937	Unit
Peak Repetitive Reverse Voltage	V_{RRM}						
Working Peak Reverse Voltage	V_{RWM}	50	100	200	400	600	V
DC Blocking Voltage	V_R						
RMS Reverse Voltage	$V_{R(RMS)}$	35	70	140	280	420	V
Average Rectified Output Current (Note 1) @ $T_A = 55^\circ\text{C}$	I_O	1.0					A
Non-Repetitive Peak Forward Surge Current 8.3ms Single half sine-wave superimposed on rated load (JEDEC Method)	I_{FSM}	30					A
Forward Voltage @ $I_F = 1.0\text{A}$	V_{FM}	1.2					V
Peak Reverse Current @ $T_A = 25^\circ\text{C}$ At Rated DC Blocking Voltage @ $T_A = 100^\circ\text{C}$	I_{RM}	5.0 100					μA
Reverse Recovery Time (Note 2)	t_{rr}	200					nS
Typical Junction Capacitance (Note 3)	C_j	15					pF
Operating Temperature Range	T_j	-65 to +125					$^\circ\text{C}$
Storage Temperature Range	T_{STG}	-65 to +150					$^\circ\text{C}$

Note: 1. Leads maintained at ambient temperature at a distance of 9.5mm from the case
2. Measured with $I_F = 0.5\text{A}$, $I_R = 1.0\text{A}$, $IRR = 0.25\text{A}$. See figure 5.
3. Measured at 1.0 MHz and applied reverse voltage of 4.0V D.C.

1N4933 – 1N4937

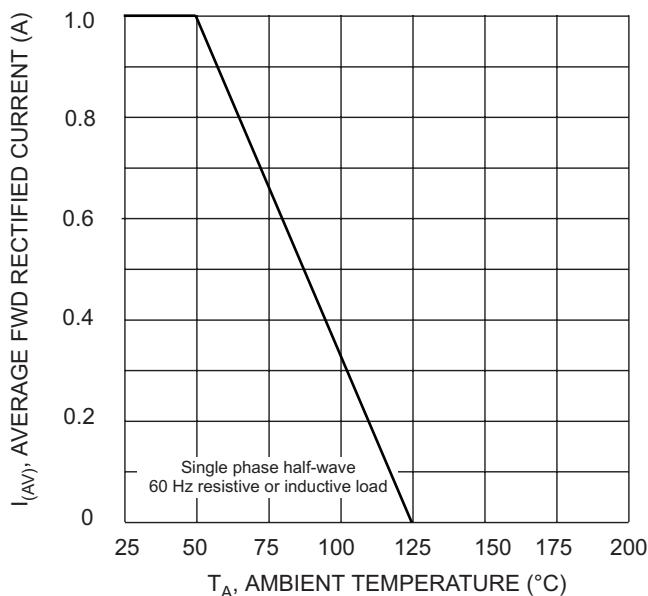

Fig. 1 Forward Derating Curve

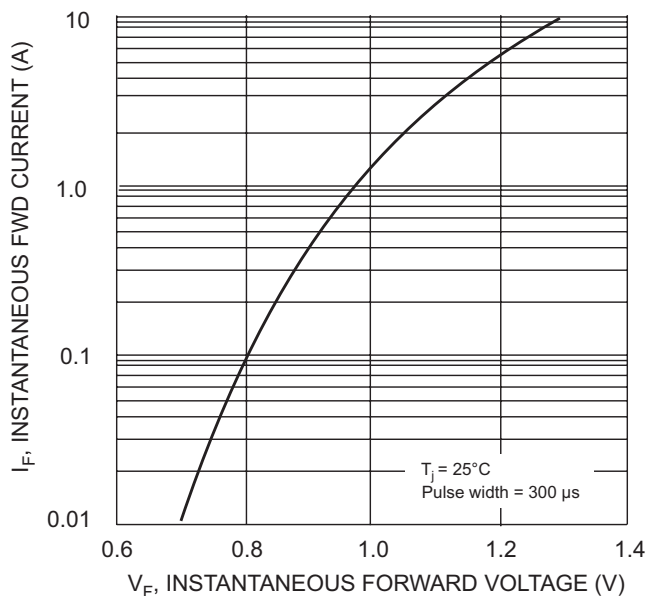

Fig. 2 Typical Forward Characteristics

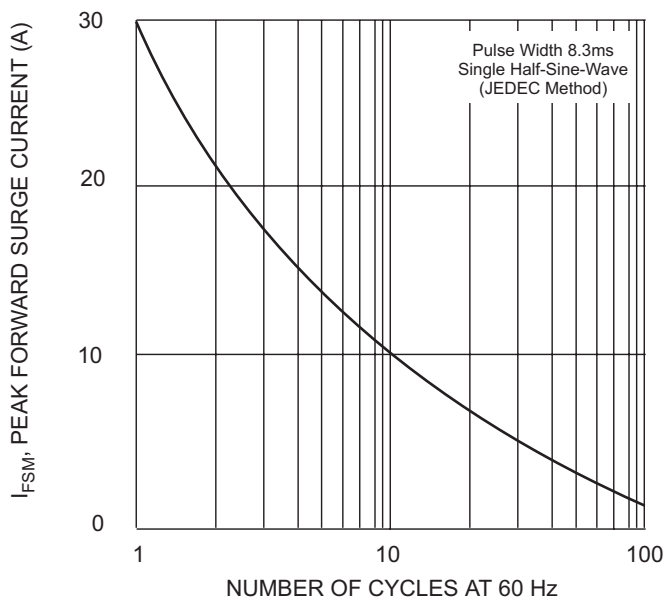

Fig. 3 Peak Forward Surge Current

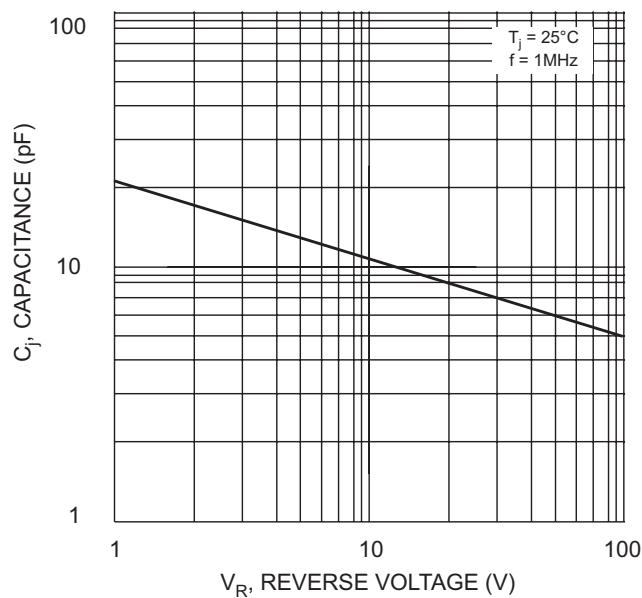
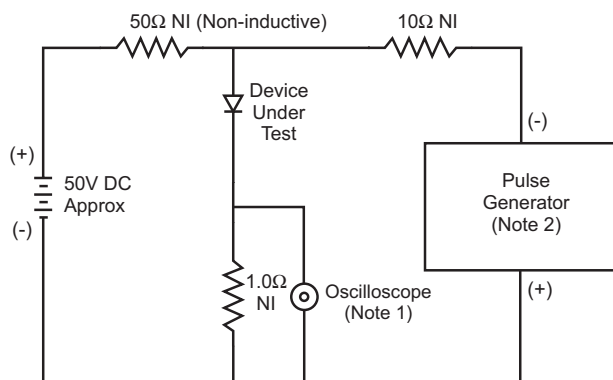
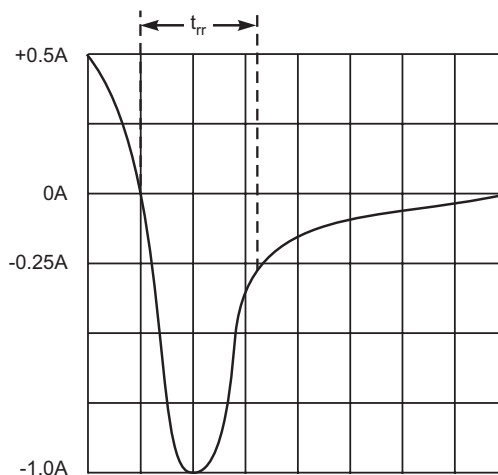

Fig. 4 Typical Junction Capacitance



- Notes:
1. Rise Time = 7.0ns max. Input Impedance = 1.0MΩ, 22pF.
 2. Rise Time = 10ns max. Input Impedance = 50Ω.



Set time base for 5/10ns/cm

Fig. 5 Reverse Recovery Time Characteristic and Test Circuit